

DIGITAL INDUSTRIES SOFTWARE

Designcenter X NX Value Based Licensing add-on modules

Extending product development features and capabilities

Benefits

- Extend features and capabilities of Designcenter X NX software
- Configure with process-, industry- and application-specific tools
- Provides flexible token-based licensing

Summary

The Designcenter software suite is one of the most comprehensive design suites, delivering enhanced flexibility, functionality and scalability and allowing you to design for your future, from browser to desktop.

Using Designcenter enables you to shift your design process left and bring products to market faster with multidisciplinary computer-aided design (CAD), computer-aided manufacturing (CAM) and computer-aided engineering (CAE) capabilities in Siemens Digital Industry Software's Designcenter NX™ software and Designcenter Solid Edge® software for designing, validating, simulating, visualizing and manufacturing.

Designcenter X NX software is Designcenter NX on the cloud, providing the features and functionality of traditional Designcenter NX on the same architecture, plus the added flexibility, security and scalability benefits of a software as a service (SaaS) solution. With Designcenter X NX, you can experience a flexible user experience powered by Siemens Digital Industries Software's cloud-centralized license management, configuration and updates, enabling you to focus less on information

technology (IT) and more on innovation. Designcenter X NX also includes secure and trusted built-in data management capabilities, allowing you to get started with effective real-time collaboration immediately with a user dashboard, task management, communication and documentation and part tracking. With seamless integration with NX CAM, the Teamcenter® Share app and Simcenter™ 3D software, you can easily scale your engineering product lifecycle across the Siemens Xcelerator platform. Siemens Xcelerator as a Service, including Designcenter X NX software, leverages leading cloud technology for data protection and data security and has been independently verified for data security and integrity by third-party security testing. More information on how Siemens is protecting your data can be found at www.sw.siemens.com/en-US/trust-center.

Designcenter X NX solutions are preconfigured, cloud SaaS tiered solutions. Designcenter X NX Essentials, Designcenter X NX Standard, Designcenter X NX Advanced and Designcenter X NX Premium are tailored to specific product development roles, practices and processes, with value-added upgrades moving you from one tier to the next.

You can extend and enhance the functionality of Designcenter X NX Standard, Advanced and Premium solutions exclusively through cost-effective and flexible value-based licensing (token licensing).

With just one Designcenter X NX Value Based Licensing subscription, token licensing provides you with extra flexibility, as you can use the tokens to check-out any add-on module product that is part of the token pool when needed and then check it back in when done, releasing the token amount used for the module back for the next person to use. You also receive immediate access to new functionality as it is released into the pool. With Designcenter X NX Value Based Licensing, you can customize and configure your Designcenter X NX solutions with access to over 100 add-on modules that include specialized design tools, standard parts applications, design-integrated simulation solutions, customization toolkits, direct translators, industry-specific applications and more. Designcenter NX, Designcenter Solid Edge, Simcenter and Teamcenter are part of the Siemens Xcelerator business platform of software, hardware and services.

All modules included in this fact sheet are part of the value-based licensing pool. Each module has a specific token value assigned for use. Modules marked with an asterisk (*) are available for Designcenter X NX with Teamcenter X Premium, Teamcenter on-premises or native data management and are currently not available for Designcenter X NX with built-in data management.

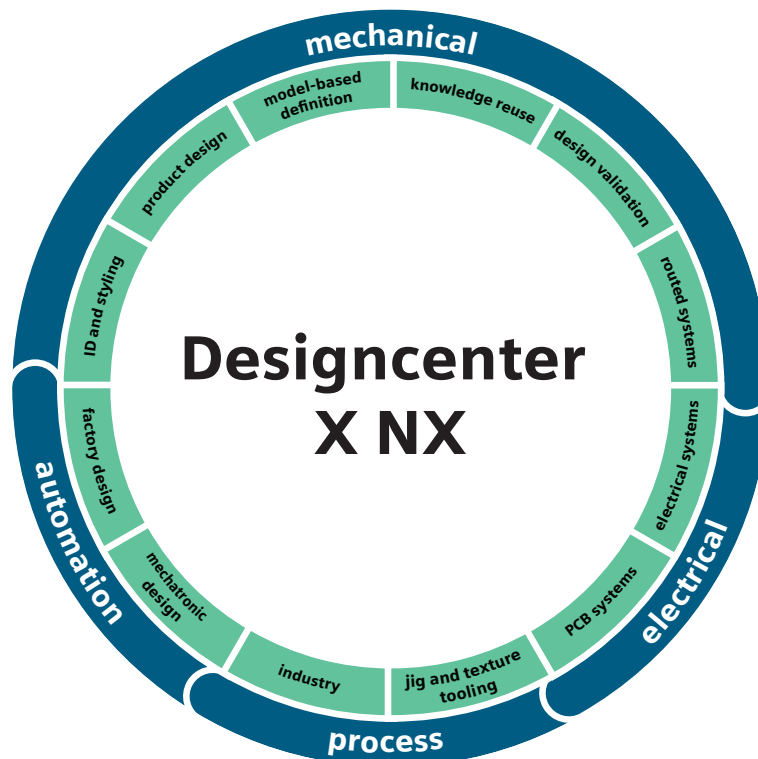

*Not available with built-in data management

Core applications

Designcenter NX includes various core functionalities that enable you to exchange data between proprietary systems and Designcenter NX, check designs in full size with virtual reality (VR) tools and give you an extra boost in usability with artificial intelligence (AI)-powered command prediction.

Designcenter NX Translator for STEP AP242

Achieve bidirectional translation using the STEP AP242 translation protocol.

Designcenter NX Translator for CATIA V4

Achieve bidirectional translation between CATIA V4 and Designcenter NX. Access files from the file open, file save as, file import and file export dialogs. This tool flattens assemblies to a single level for import and export.

Designcenter NX Translator for CATIA V5

Use this module for bidirectional translation and to read CATPart and CATProduct files. This tool reads coordinate systems, points and part substructure, geometry, assembly structure and attributes of color, layer and name into Designcenter NX.

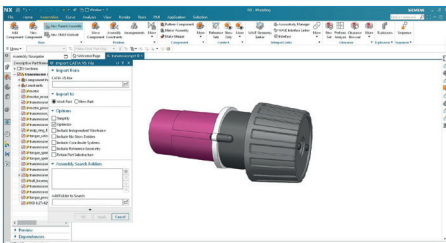

Designcenter NX Translator for Creo

Read Creo Parametric solids and surfaces from .prt and .asm files and create an Designcenter NX part or assembly.

Designcenter NX Translator for ACIS

Translate two-way data exchange between Designcenter NX and CAD models in the ACIS modeling kernel format.

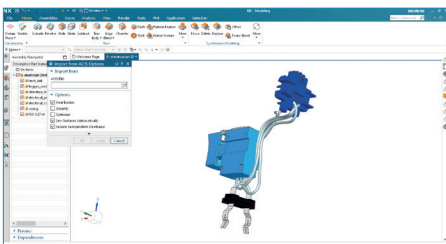

Designcenter NX Translator for IFC

Achieve bidirectional translation using the Industry Foundation Classes (IFC) file format, which describes architectural, building and construction data.

Designcenter NX Translator for Rhino

Open and import Rhino .3dm files into Designcenter NX.

Designcenter NX Translator for 3DXML

Open and import .3Dxml files into Designcenter NX.

Designcenter NX Translator for Revit

Open and import Autodesk Revit .RVT files into Designcenter NX.

Designcenter NX Translator for G3D

Open and import GOM .G3D files containing a tessellated mesh into Designcenter NX as a Convergent Body.

Designcenter NX Command Prediction

The machine learning (ML) or AI-enabled user interface (UI) can predict and provide commands to the user based on learned command use patterns. It allows you to personalize the design environment by considering the differences in knowledge, style and preferences. Leveraging and sharing learned command use data reduces the learning curve, promotes using domain- and/or industry-specific best practices and increases productivity.

Designcenter NX Select Similar Faces

Designcenter NX Select Similar Faces software performs operations on geometrically similar regions with fewer clicks.

Designcenter NX Voice – Command Assistant

Realize productivity gains with easy-to-use speech-to-text commands that transform multiple levels of menus and clicks.

Designcenter NX Viewer

Open, view and measure Designcenter NX models and drawings in the native Designcenter NX format. This is ideal for when you have access to and need to view Designcenter NX data but do not intend to save or reauthor Designcenter NX data.

Designcenter NX DMU and Markup*

Access a digital mockup (DMU) and markup functions, including Create DMU Workset, Create Snapshot, Manipulate Snapshot, Insert Product, Move in Workset, Reset to Design State and Add Markups.

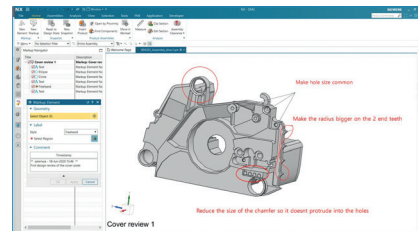

Designcenter NX DMU and Markup Add-on for Designcenter NX Viewer*

Perform digital mockup functions in Designcenter NX Viewer.

Designcenter NX Extended Reality

Publish 3D product designs to a range of augmented, virtual and mixed reality (MR) workflows and share your ideas easily with colleagues or customers. You can use the Designcenter NX Extended Reality output across a range of augmented reality (AR) and VR experiences, which a variety of browsers natively support.

*Not available with built-in data management

Designcenter NX Appearance Management

Set up a series of visual appearances quickly and easily on a single master model. When combined with Designcenter NX Render, you can create a high-quality render of these visual appearances for design reviews or marketing assets.

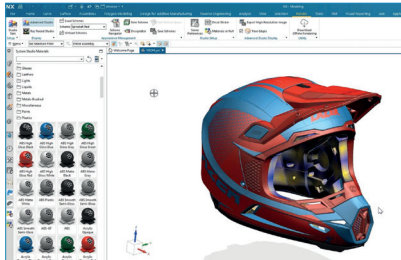

Designcenter NX Appearance Management for Managed User

Define an appearance product scheme to manage a product’s appearance variability when managing design data with Teamcenter.

Designcenter NX Multi-User Design Notification*

Use Designcenter NX Multi-User Design Notification to leverage a collaborative design environment. This module enables proactive notifications of changes in your design context.

Designcenter NX Smart Context Designer*

With Designcenter NX Smart Context Designer software, an Designcenter NX managed user can create, open and save a product workset containing one or more filtered product assemblies and view the product data via a partition scheme. Additionally, using Smart Discovery enables you to search, filter and retrieve information.

Designcenter NX Immersive Explorer

Immerse yourself in various environments using the Designcenter NX Immersive Explorer software and a desktop mode or a VR headset. With design review tools in this immersive environment, such as Drawing Notes, Measure, Assembly Navigator, Sticky Notes, Snapshot and Section, engineers, managers, stakeholders and end-users can review and gain valuable insights on their designs.



Designcenter NX Immersive Designer

Interact with and manipulate 3D digital models as if they were physical objects in an immersive space. This module requires using the Sony XR head-mounted display for visuals and controllers. With the Sony XR-head mounted display and Designcenter NX Immersive Designer, you can design products in high fidelity with Designcenter NX capabilities in the real world via an immersive experience. Reach out and touch your designs at scale, leverage multiple virtual monitors while working simultaneously with a traditional keyboard and mouse, directly edit virtual models without exiting your immersive environment and interact with designs using hand controllers.

Designcenter X NX Immersive Collaborator

Collaborate in real time within a shared immersive space. With Designcenter X NX Immersive Collaborator, you can realize more effective product reviews and achieve immediate input and validation from anywhere in the world.

AI Select Similar Components

Leverage AI Select Similar Components to declutter assemblies and boost productivity through reducing the number of clicks for performing operations. Machine learning-enabled shape recognition selects geometrically similar components that can then have the same operation performed on all selected components simultaneously.

AI Selection Prediction

Enable productivity gains for multiple select workflows. The AI Selection Prediction framework predicts input selection entities. You can preview predicted objects with a user-defined attention color, select the predicted objects and add or remove predicted entities from the selection list.

Designcenter NX Copilot

Ask natural language questions, access detailed technical insights and streamline complex design tasks to design faster and smarter with less errors and rework.



*Not available with built-in data management

Mechanical

Industrial design and styling

Create aesthetically appealing, innovative products with fast concept design, freeform shape modeling and surfacing capabilities, including subdivision modeling, Class-A surfacing and reverse engineering. Additionally, use enhanced visualization with dynamic and real-time photorealistic rendering tools to create visually stunning models.

Designcenter NX Render

Create photorealistic images for design reviews, marketing assets and sales collateral by leveraging best-in-class rendering technology. Creating the perfect-looking image is easy with the addition of an all-new set of render-ready materials. Simply drag-and-drop materials, lighting and cameras into your scene in minutes to achieve desired results with accurate texture and reflection.



Designcenter NX Realize Shape

Use subdivision modeling methods to create advanced 3D product shapes with unprecedented speed and ease of use. The toolset is equally suited for creating quick 3D concepts or high-quality final surface shapes. Since Designcenter NX Realize Shape™ software is fully integrated with all Designcenter NX modeling functions, it seamlessly incorporates traditional modeling approaches, which allows you to achieve a high degree of design refinement.

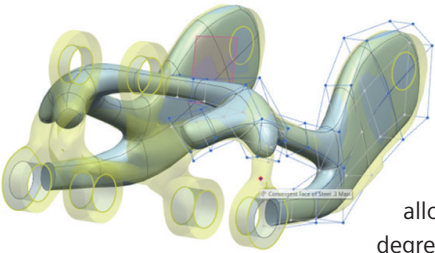

Designcenter NX Draw Shape

Freehand draw wireframe shapes on bodies, enabling you to visually convey and communicate aspects of the design prior to investing in 3D models.

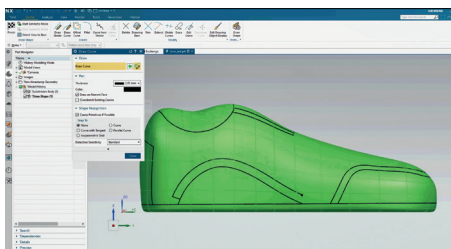

Product design

The core modeling capability of Designcenter NX combines wire-frame, surface, solid, parametric and direct modeling in a single environment. This enables designers to choose the most appropriate tool for the task at hand. By leveraging capabilities such as synchronous technology and Convergent Modeling™ technology, it is easy to edit designs with simple push-pull methods and work with facet or mesh data in the same modeling environment. The adaptive UI of Designcenter NX uses ML to help improve productivity.

Designcenter NX WAVE Control

Define interpart relationships for parametric assembly modeling using Designcenter NX WAVE™ Control feature functionality, which is a geometry linking tool. With Designcenter NX WAVE assembly control structures and constraints, you can simplify design changes and accelerate the modeling of configurations, options and variants.



Designcenter NX Assembly Path Planning

Designcenter NX Assembly Path Planning software automatically determines the optimal, interference-free path for extracting a component from an assembly. It stores the resulting path as a set of steps within an assembly sequence. You can use the extraction path to streamline serviceability studies by verifying component access without requiring a physical prototype or extensive analysis.

Designcenter NX Structure Designer*

Create structural frames more efficiently by leveraging the easy-to-use structural frame modeling capability in the Designcenter NX Structure Designer software. Additionally, you can generate structural frames in minutes using the frame drawing assistant, which can create 2D skeletons with minimal clicks.

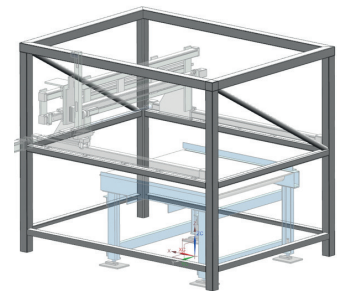

Designcenter NX Platform Design

Design equipment support structures, accessways, walkways, maintenance platforms and similar steel structures with these specialized tools to maximize productivity for modeling platforms,

*Not available with built-in data management

plating of platforms, reinforcements, corner conditions, handrails, stairs and ladders.

Designcenter NX Topology Optimizer

Automate improving structural designs while meeting various performance, material and manufacturing requirements with Designcenter NX Topology Optimizer. It contains powerful optimization capabilities, including the ability to set up and optimize a single component or system assembly. Additionally, you can add various design and manufacturing constraints to control the optimization results, such as design symmetry, offset, shelling, blending, additive overhang angles, additive self-supporting, additive material spreading, molding, casting, machining and extrusion.

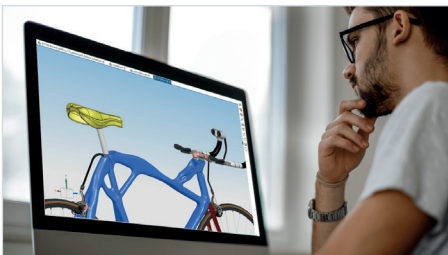

Designcenter NX Design Space Explorer

Designcenter NX Design Space Explorer includes multiple objective design space exploration and optimization capabilities.

Designcenter NX Performance Predictor

With Designcenter NX Performance Predictor software, perform quick simulations to review their product's design performance regarding simulation results. This allows them to evaluate design change impacts in the Designcenter NX design environment earlier.

Designcenter NX Advanced Sheet Metal

Model complex sheet metal parts that contain drawn features and nonlinear bend lines. With the advanced flange function, you can easily create nonlinear flanges using customer input parameters or existing geometry to define shapes and specify end limits. The completely revised joggle function enables you to add complex joggles to flanges or tabs, including single and multiple jogs. The flat pattern feature provides rich data for downstream consumption.

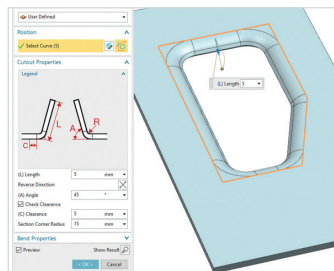

Designcenter NX Fabric Flattener

Generate flat patterns for woven or unidirectional fabric materials. Additionally, flatten composite laminate plies or any material that conforms to the theoretical models for woven or unidirectional fabrics.

Designcenter NX Weld Assistant

Create welds, structural adhesives and mechanical connection features. This includes resistance spot welds, mechanical clinches, arc welds in the shape of fillets, butts, J bevels, V bevels and flared bevels. Additionally, you can generate sealer beads with any cross-sectional shape and defined spray-on adhesive, mastic or glue. There are also validation checks for all discrete weld types, along with import and export capabilities. An automatic annotation function generates standard weld symbols and product manufacturing information, and you can publish all weld features to Teamcenter when using managed mode.

Designcenter NX Physical Architecture Diagram Author*

You can use this module for model-based systems engineering (MBSE) and for managing and tracing large numbers of product and technical requirements throughout the design process. It can show connections such as WAVE links, assembly constraints and dimensions between components of a 3D assembly and show the current validation status of associated Designcenter NX Requirements. This package can be used standalone in Designcenter NX or in conjunction with Teamcenter Parameter Management.

Designcenter NX Physical Parameter Management Author*

Use this add-on for MBSE and for managing and tracing large numbers of product and technical requirements throughout the design process. It manages mechanical requirements and reports on measured results for master 3D and CAE models. This can be used as a standalone feature in Designcenter NX or in conjunction with Teamcenter Parameter Management.

Designcenter NX Physical Architecture Diagram Viewer*

View connections such as WAVE links, assembly constraints and dimensions between 3D assembly components and report on the status of requirement checks on measurement.

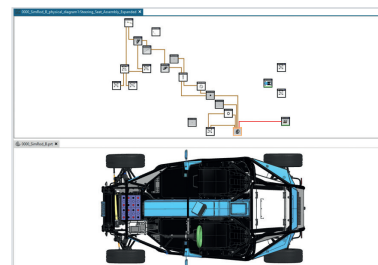

Designcenter NX Physical Parameter Management Viewer*

View reports on measurements in the CAD model and the status of checks on values from the CAE results performed in other applications.

*Not available with built-in data management

Designcenter NX Join

Reduce the time spent placing and defining fasteners and hardware while improving fastener assembly design quality using Designcenter NX Join software. You can define standard join features with information and attributes about the connection between assembly components. This module covers the basic definition of point-based connections, including rivets, bolts, adhesives and spot welds.

Designcenter NX Advanced Convergent Modeling

Seamlessly work with mesh geometry in an integrated CAD workflow. Using this add-on, it becomes much easier to work with data from 3D scanners, polygon modelers, simulation software and topology optimization. Additionally, it makes it easier to prepare mesh (STL) geometry for 3D printing.

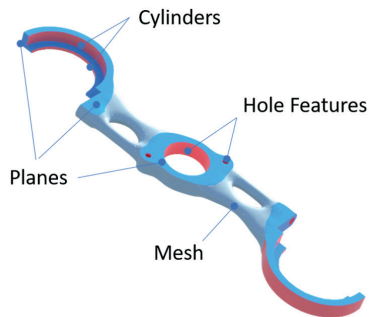

Designcenter NX Implicit Modeling

Create equation-driven structures and perform robust modeling operations on complex designs. Additionally, design advanced geometric shapes with relative ease and complex operations between geometry that have a high degree of robustness over more traditional methods like boundary representation (B-rep) modeling. Using features of Convergent Modeling and Designcenter NX, you can present these results in a usable format for downstream modeling and simulation/manufacturing operations.



Designcenter NX Advanced Assemblies

Simplify components or subassemblies into a single, lightweight solid, enclose assembly geometry in an envelope of planar faces, partition assemblies into meaningful regions and manage the weight and other mass properties of components and assemblies.

With component filtering techniques, quickly identify and load relevant components, avoiding unnecessary delays and screen clutter from loading irrelevant components.

Designcenter NX Design for Additive Manufacturing

This add-on includes capabilities that aid you in designing parts that are suitable for production using additive manufacturing or 3D printing.

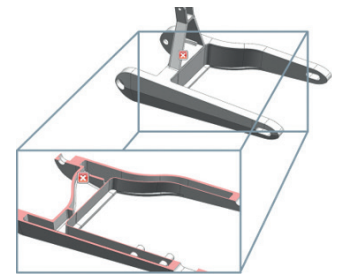

Designcenter NX Composites

Designcenter NX Composites software includes the capability to develop end-to-end composite parts directly in Designcenter NX with integrated model interrogation and design for manufacturing tools.

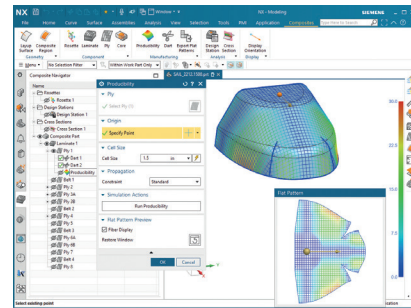

Designcenter NX Composites Laser Projection Interface

Generate laser projection controller data for layout assistance in manufacturing composite parts.

Designcenter NX Composites CAE Interface

Send as-manufactured composite ply data to CAE for structural analysis of composite parts.

Designcenter NX Sustainability Impact Analysis

Perform sustainability calculations and rollups at any product design phase with the Designcenter NX Sustainability Impact Analysis software. Additionally, conduct what-if analyses and ML-driven optimizations.

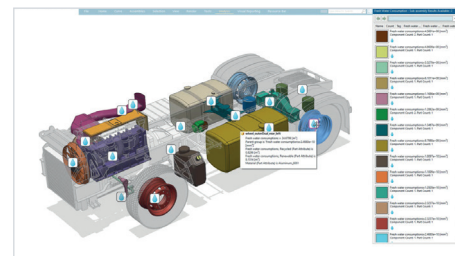

*Not available with built-in data management

Designcenter NX Lattice Designer

Using Designcenter NX Lattice Designer software, create various types of performance-optimized lattice structures as convergent geometry for lightweighting, energy absorption, thermal management, osseointegration, etc.

Designcenter NX Author for ECLASS*

Document a design part to the ECLASS classification standard, improving communication along the value chain. Requires prerequisites of Teamcenter Classification for ECLASS and Classification User.

Model-based definition

Produce a complete digital definition of a product within a 3D model by leveraging the model-based definition (MBD) capabilities in Designcenter NX. Establishing the model as the single source of truth reduces the time spent on engineering documentation, drives downstream tools for validation and manufacturing and reduces late changes and scrap.

Designcenter NX Product and Manufacturing Information

Product and manufacturing information is nongeometric data applied to a 3D model to convey information about the design of a product's components for manufacturing. This contributes to MBD by conveying information such as geometric dimension and tolerance (GD&T), 3D annotation, surface finish and material specifications.

With the Designcenter NX Product and Manufacturing Information solution, you can produce a complete digital definition of a product within a 3D model, eliminating the need for traditional drawings.

Designcenter NX Model Based Definition

Designcenter NX Model Based Definition software is an add-on to the Designcenter NX Product and Manufacturing Information application. This add-on includes advanced capabilities that support MBD deployments, including automatically authoring product and manufacturing information (PMI) and user-defined rules. This functionality incorporates an interactive Logic Editor diagramming interface that supports building and executing rules for authoring PMI. With Designcenter NX Model Based Definition rules, topological feature recognition with associative updating enables you to work with full-featured models or featureless data.

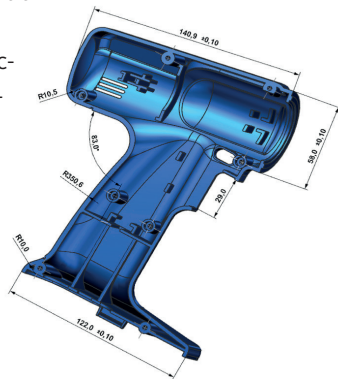

Designcenter NX PMI Effectivity*

Determine which PMI on a model is relevant for each product configuration when you are designing products that contain many variations. Additionally, infer the effectivity of PMI objects based on the referenced geometry. This displays only PMI objects that are relevant to the selected product configuration.

Designcenter NX Coatings*

Define paint and coating information in the CAD model, including coating material, face and boundary location and thickness with the Designcenter NX Coatings software. Afterwards, you can define the coating. include it in the mass properties calculation, annotate it using PMI or drawing notes and include it in the parts list rollup or bill-of-materials (BOM).

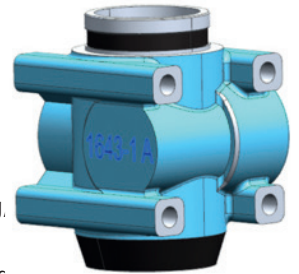

Knowledge reuse

With the knowledge reuse capabilities in Designcenter NX, you can shorten design cycles, reduce development costs and improve productivity. Additionally, by leveraging knowledge-driven automation capabilities, your company can capture, reuse and consistently apply best practices across product lines.

Designcenter NX Algorithmic Modeling

Create algorithmically driven designs as well as design and automate advanced variational, parametric shapes that are not possible with traditional interactive CAD modeling. This module uses a novel, logic editor-based approach to build an algorithm that defines the shape and variability of a design, provides an easy-to-use interface and creates automation and design templates.

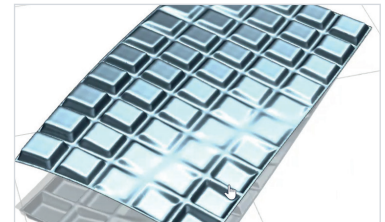

Designcenter NX Product Template Studio Author

You can use templates to modularize a design, breaking a complex assembly into manageable modules, which you can recombine as needed to configure complex products. With Designcenter NX Product Template Studio Author, you can add a user-defined interface to any parametric model, which you can intuitively describe and package parametric models for later reuse.

Designcenter NX Product Template Studio Consumer

Display and interact with user-defined template interfaces created in the Product Template Studio Author application. This consumer license also enables the template model UI to be automatically invoked as you leverage template models from the Designcenter NX Reuse Library.

*Not available with built-in data management

Designcenter NX HD3D Visual Reporting

You can use Designcenter NX HD3D Visual Reporting software to display information of interest from your company's data sources directly into the 3D product design environment. Make unambiguous assessments, interpret information more accurately and synthesize product and process data rapidly to make correct design decisions. Designcenter NX HD3D Visual Reporting comes with a set of predefined, OOTB reports that design teams can use to answer commonly asked questions. Reports related to ownership, check-out, part maturity, projects, load status, validation status and more are available for instant use. With the authoring capability, create and modify custom reports to extract and present the data.

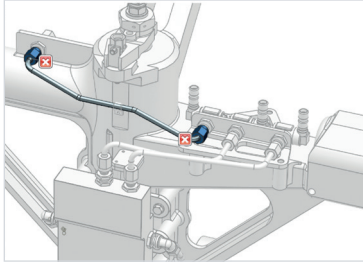

Designcenter NX One-Step Formability Analysis

Conduct a quick and accurate finite element modeling (FEM) sheet metal forming analysis and leverage tools for creating flattened blanks and preforms from complex freeform geometry.

Designcenter NX Mold Cooling

Designcenter NX Mold Cooling software includes wizard-based capabilities you can leverage to rapidly simulate the thermal performance of injection mold inserts, identify hotspots and uneven temperatures on the parts, generate reports and compare performance between design iterations. You can perform 1D duct flow simulation and 3D computational fluid dynamics (CFD) simulation.

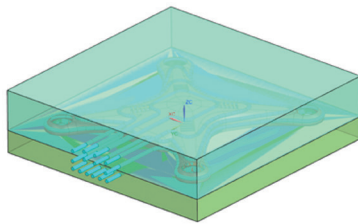

Designcenter NX DFM Advisor

Execute design for manufacturability (DFM) checkers to identify costly and problematic manufacturing areas on your design model. Customize your checker parameters to meet specific design standards.

Designcenter NX CFD Designer

Perform flow and thermal simulations within the design environment to streamline the design process and make decisions quicker. You can simulate with internal and external steady-state fluid analyses; laminar, turbulent and transitional flows; liquids and gases; conjugate heat transfer and porous media. View analysis results in Designcenter NX or open the model in Simcenter FLOEFD for more advanced simulation.

Routed systems

Designcenter NX digital product development solutions include an integrated suite of tools that can be used to facilitate the entire design process for routed systems, including wire harnesses, cables, piping, tubing, conduit and raceways. Using these process-specific tools reduces detailed design time, improves product quality and transfers product information seamlessly between the logical design, physical design, analysis, manufacturing and service domains.

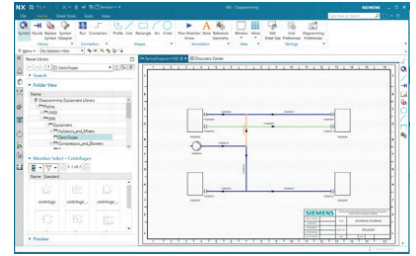

Designcenter NX Diagramming

Designcenter NX Diagramming software is a multidisciplinary diagram creation solution for various industries with an environment for positioning and connecting equipment from standard or custom equipment libraries into logical 2D diagrams via superior diagram creation tools. It includes a specific task environment to easily create new symbol libraries and runs and branches in the diagram that can then connect with real 3D equipment.

Designcenter NX Routing Base

Designcenter NX Routing Base incorporates the core capabilities all Designcenter NX-routed system design solutions use. This includes the general capabilities you need to create, edit, copy and move paths. Additionally, there are tools for defining standard part libraries, selecting parts from libraries and intelligently placing standard parts within the paths. Also, define standard stock specifications and assign them to paths.

Designcenter NX Routing Piping and Tubing

Optimize piping and tubing design workflows using intelligent path creation, specification-driven part selection, smart part placement, collision detection, weight calculations and knowledge rules that concurrently validate designs against company and industry standards. These tools support rigid and flexible pipes and tubes.

Designcenter NX Routing HVAC

Create, modify, validate and document heating, ventilation and air conditioning (HVAC) systems. Additionally, optimize HVAC design workflows using intelligent path creation, specification-driven part selection, smart part placement, collision detection, weight calculations, duct splits, duct size calculation and knowledge rules that concurrently validate designs against company and industry standards. This application includes predefined catalogs of HVAC parts and parametric templates that you can modify quickly (smart sizing) to fit any space constraints. Together with other Designcenter NX capabilities, like hangers and sheet metal flat patterns, you can leverage a complete lifecycle solution for HVAC design.

Designcenter NX Penetration Management*

Create, manage and respond to penetration requests between various user groups responsible for steel structures and routed system design. The process begins with a routed system designer (such as a piping designer) who requests pipe penetrations with structures that another design group designs and maintains, such as a structure group. A penetration request defines the location of the required cutout and initiates a workflow that the end-user can customize to meet specific needs. A typical workflow includes several review steps you must complete before creating a cutout to satisfy and close the request.

Electrical

Electrical systems

Designcenter NX includes advanced software tools you can use for developing complete electrical systems, from electrical or electronic architecture definition to detailed electrical design and wire harness manufacturing to documentation and diagnostics.

Designcenter NX Routing Cabling

Route electrical cables in a product assembly along with typical mechanical parts and supporting equipment, such as conduit and raceways. The software can automatically find paths routed between devices and assign the cable descriptions to the path segments. It can also automatically add cable lengths and diameters to the connection list for feedback to upstream electrical CAD (ECAD) applications or downstream manufacturing applications.

Designcenter NX Cable Router

Designcenter NX Cable Router is an interactive interface to the Designcenter NX Cable Routing functionality, which cable routing engineers can use to route and visualize a high volume of cables using interactive or automatic routing methods. This includes the ability to search cables based on multiple criteria, visualize start and end devices and set rules and preferences. Additionally, optimize cable routing for large vessels and accelerate cable route visualization, reducing cost and time and guiding designers to the right decisions.

Designcenter NX Routing Harness

Route an electrical wiring harness consisting of bundles of wires and specify typical mechanical parts and supporting equipment, such as connectors and other devices. Also, import the wiring characteristics for connections between electrical devices. Physical wire lengths and diameters can be automatically added to the connection list for feedback to upstream ECAD applications or downstream manufacturing applications.



PCB systems

You can use Designcenter NX for designing both flexible and rigid printed circuit boards (PCBs). Based on workflows common to designing PCBs, the PCB design tools help model printed circuits rapidly and accurately for assembly and send the outlines to manufacturing or an ECAD system for further refinement.

Designcenter NX Flexible Printed Circuit Design

Model printed circuits rapidly and accurately in the context of an assembly and send the outlines to manufacturing or to an ECAD system for further refinement. Additionally, check the printed circuit model developed in Designcenter NX for clearances and tolerances and transfer the finished board model to an ECAD system for component placement and circuit trace or layer development.

Process-based applications

Jigs, fixtures and tooling

Automate the entire tool development process, including part design, tool assembly layout, detailed tooling design and validation using advanced Designcenter NX functionality. With step-by-step guidance and associativity to part designs, you can work with even the most challenging tooling and fixture designs.

Designcenter NX Mold Wizard

Create designs quickly and efficiently with this working environment of supporting functions and component data for mold designs. Employ a process thread approach to identify and develop the critical functions necessary to complete mold design tasks. This approach includes implementing tools that simplify, automate and guide you through the tasks involved in designing plastic injection molds.

Designcenter NX Molded Part Designer

Designcenter NX Molded Part Designer software includes molded part validation and simulation tools for product designers to get their product design closer to the finished product without going through costly iterative and prototyping processes.

Designcenter NX Electrode Design

Streamline the design and production of electrodes for electrical discharge machining (EDM). Automate and effectively design, validate, document, manufacture and manage the entire electrode development process from design to production.

*Not available with built-in data management

Designcenter NX Progressive Die Wizard

Construct progressive stamping dies. When planning the forming process, define preprocesses, unfold the part, perform formability analysis (using Designcenter NX One-Step Formability Analysis), nest the flat pattern (blank layout), design the scrap and determine the strip and tool layout.

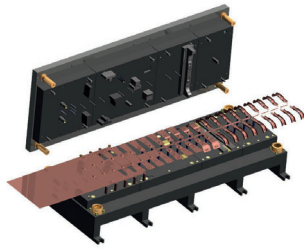

Designcenter NX Die Structure Design

Create blank, draw, trim and flange dies and associated transfer equipment for stamping sheet metal parts.

Designcenter NX Die Engineering

Leverage process-specific tools for die face design in a wizard environment.

Designcenter NX Molded Part Validation

Analyze parts and automatically get information about draft angles, undercut areas, sharp corners, small radiuses and other items that could compromise molding quality. Also, visually check the core and cavity sides easily.

Designcenter NX Conformal Cooling Channel Design

Automate creating the conformal cooling channel on 3D-printed metal mold inserts, such as a core and cavity. This eliminates many manual modeling processes that improve the creation of conformal cooling channels for mold inserts.

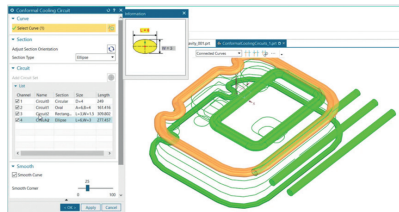

Designcenter NX Tooling Locators

Using Designcenter NX Tooling Locators software provides the ability to generate and manage datum locators and measurement points typically used in creating an assembled structure. Assign connected parts to aid in coordinating and configuring datums to automatically determine the control direction. A variety of measurement point types are supported, including surface, trim, hemmed edge, hole, slot and stud.

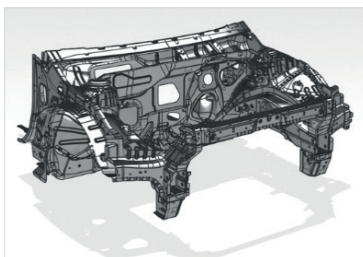

Industry-specific applications

Designcenter NX includes workflow solutions built for the specific needs of individual industries, with modules for aerospace design, vehicle design automation (VDA), ship structure design, human modeling and automation engineering of production systems.

Designcenter NX General Packaging

This VDA software, Designcenter NX General Packaging, is a set of software assistants and advisors that you can use to automate a wide range of tasks associated with a vehicle's mechanical, safety, vision and occupant packaging. The vehicle design automation functionality checks designs for compliance with international standards and local country regulations.

Designcenter NX Aerospace Design

Includes a set of tools (aero step, aero rib, aero shelf and aero flange) specifically tailored for designing aerospace parts.

This module also includes Designcenter NX

Advanced Sheet Metal tools for creating non-straight brake formed parts.

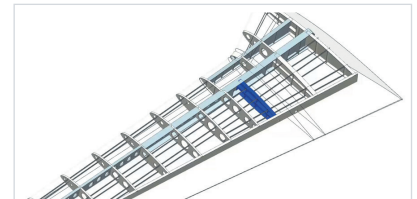

Designcenter NX Ship Structure Basic Design*

Quickly model a preliminary macro view of the ship based on inputs available from the concept design stage. Also, easily model and modify a structural macro view of the ship to support early design stage analysis, drawing generation and the transition to detail design. The basic design model includes hull, plate and profile systems that they can further split with seams into smaller subsystems. Define decks, bulkheads, pillars, stiffeners and edge reinforcements. Additionally, add standard parts, brackets and cutouts to the basic design model. The resulting models can be used in gross material estimates and weight and center of gravity calculations. The basic model transitions seamlessly to a detailed design.

Designcenter NX Ship Structure Detail Design*

Define and modify a ship's structural detail parts. This module includes tools for parametric detail feature definition for quickly placing and modifying plates, stiffeners, brackets, holes, profile cut-outs, clips and collars, chamfers, end cuts, corner features, edge features and flanged plates.

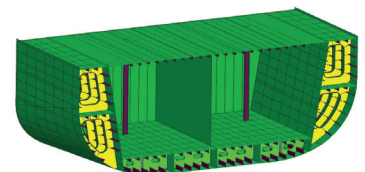

Additionally, create structural pillars and apply insulation material to steel surfaces. All data generated from this application can be used for manufacturing and production planning outputs.

*Not available with built-in data management

Designcenter NX Ship Structure Manufacturing

Preparation*

Create data for structural part fabrication and generate manufacturing parts from the detailed design parts within a manufacturable unit and restructure it to organize parts and enable welds distribution within the manufacturing assembly structure.

Designcenter NX Ship Manufacturing Super Plate*

Combine two or more planar manufacturing plate parts to form a Super Plate part using the Designcenter NX Ship Manufacturing Super Plate software. Additionally, it copies all manufacturing processes that already run on the individual plate parts, like the cutting side face, reference line, excess material, weld information, etc., to the Super Plate.

Designcenter NX Ship Drafting*

Create the necessary drawings for classification approval. Additionally, create frame bars on drawing views along with shipbuilding-specific baseline dimensioning methods. Also, automatically annotate ship section drawing views to include stiffener section symbols, structure identification symbols, filling line representations, scantling information and continuity symbols. Add annotations to each ship structure object and control the color, fonts and widths of the ship's structure lines.



Designcenter NX Ship General Arrangement Design*

Create quick and accurate proposals for new ships based on customer requirements during the concept design phase. Leverage tools for creating a 3D model of the general arrangement of a ship and its corresponding 2D drawings. This includes the capability to initialize the general arrangement design process based on a configurable product structure, along with defining the concept grid model and the deck-based breakdown of the ship. Detail each deck into room spaces based on a specific purpose. Also, calculate the net and gross volume and surface area for each space. Additionally, add standard equipment, parts and accommodation-related items from the reuse library to these spaces.

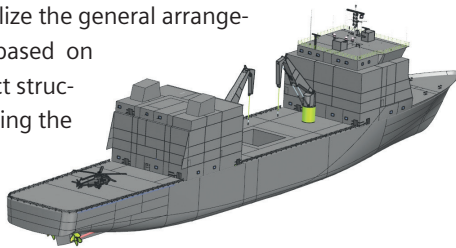

Designcenter NX Rules-based Structure Welding*

Automatically define welds in the 3D model and generate a lightweight object to represent each weld joint. This enables you to define and work with large quantities of welds in Designcenter NX. The software creates weld joints automatically based on the 3D part geometry and material, including the placement and bevel configuration. This application supports varying bevels, 3D edge preparations, automated product manufacturing information and drawing weld symbols.

Designcenter NX for BIM

Quickly create buildings in a collaborative design environment with Designcenter NX for BIM software. This module includes a library of BIM objects and features for working with a building structure, grids and elevation lines, roofs and BIM object classifications.

Designcenter NX for Concrete Design

Quickly create reinforced concrete design elements with crossing and longitudinal rebars by leveraging Designcenter NX for Concrete Design software, which is an advanced 3D parametric design tool.

Part manufacturing

Designcenter NX Staged Models

Streamline the overall staged model design process for production planning and author complete manufacturing information within the 3D staged models with the Designcenter NX Staged Models software. This includes a geometric representation of staged, PMI and other manufacturing process information.

Designcenter NX Process Planner

Enable a model-based part manufacturing process that connects directly to design data with Designcenter NX Process Planner software. With this module, you can extract and consume all contents from 3D models with model-driven and associative process definitions for part manufacturing. Easily assign and view contents needed for operations, such as staged models, stocks, tools, resources, roles and materials. Then, you can export bill-of-process (BOP) contents for downstream enterprise resource planning (ERP) or manufacturing execution system (MES) consumption.

Designcenter NX Process Modeler

Define, validate and optimize process operations, datums and tolerances with Designcenter NX Process Modeler software, a model-based alternative to the 1D/2D spreadsheet tolerance stack-up for part manufacturing. Predict part quality, process capability, key process characteristics and criticalities. With this module, you can confirm the part manufacturing process meets design requirements using upfront tolerance validation.

*Not available with built-in data management

Designcenter NX Process Instructor

Author and publish work instructions based on the BOP with all contents necessary for downstream consumption. This module is powered by live document technology, where the documentation is always live and up-to-date, showing models, attributes, images and more. You can publish the documentation in the Designcenter NX Technical Data Package module.

Automation

Mechatronic design

Break down barriers between electrical, mechanical and automation engineers with a multidisciplinary approach to machine design. With a library of joints, motors, sensors and actuators, along with kinematic and dynamic properties for each component in

Designcenter NX, rapidly perform a physics-based, interactive simulation to verify machine operation.



Designcenter NX Mechatronics Concept Designer

Build concept models that combine mechanical, electrical and software components based on system-level product requirements. This enables early conceptual design capabilities in the mechanical, electrical and automation design and engineering disciplines and their associated parallel interdisciplinary workflows, supporting a coarse to fine product development process.

Designcenter NX MCD Player

This is a read-only viewer and simulation player for models created with Designcenter NX Mechatronics Concept Designer (MCD) software. Load and play mechatronic machine simulations. Additional signal mapping capabilities are available to drive simulations using programmable logic controller (PLC) hardware or virtual software simulations of a PLC.

Designcenter X NX products key add-ons overview

(Content is subject to change)

	Available in Designcenter X NX with built-in data management	
Core		
Designcenter NX Translator for STEP AP242	Yes	Designcenter NX Physical Parameter Management Author
Designcenter NX Translator for CATIA V4	Yes	Designcenter NX Physical Parameter Management Viewer
Designcenter NX Translator for CATIA V5	Yes	Designcenter NX Join
Designcenter NX Translator for Creo	Yes	Designcenter NX Advanced Convergent Modeling
Designcenter NX Translator for ACIS	Yes	Designcenter NX Implicit Modeling
Designcenter NX Translator for IFC	Yes	Designcenter NX Advanced Assemblies
Designcenter NX Translator for Rhino	Yes	Designcenter NX Design for Additive Manufacturing
Designcenter NX Translator for 3DXML	Yes	Designcenter NX Composites
Designcenter NX Translator for Revit	Yes	Designcenter NX Composites Laser Projection Interface
Designcenter NX Translator for G3D	Yes	Designcenter NX Composites CAE Interface
Designcenter NX Command Prediction	Yes	Designcenter NX Sustainability Impact Analysis
Designcenter NX Select Similar Faces	Yes	Designcenter NX Lattice Designer
Designcenter NX Voice – Command Assistant	Yes	Designcenter NX Author for ECLASS
Designcenter NX Viewer	Yes	Model-based definition
Designcenter NX DMU and Markup	—	Designcenter NX Product and Manufacturing Information
Designcenter NX DMU and Markup Add-on for NX Viewer	—	Designcenter NX Model Based Definition
Designcenter NX Extended Reality	Yes	Designcenter NX PMI Effectivity
Designcenter NX Appearance Management	Yes	Designcenter NX Coatings
Designcenter NX Appearance Management for Managed User	Yes	Knowledge reuse
Designcenter NX Multi-User Design Notification	—	Designcenter NX Algorithmic Modeling
Designcenter NX Smart Context Designer	—	Designcenter NX Product Template Studio Author
Designcenter NX Immersive Explorer	Yes	Designcenter NX Product Template Studio Consumer
Designcenter NX Immersive Designer	Yes	Designcenter NX Integration to Geolus
Designcenter X NX Immersive Collaborator	Yes	Designcenter NX Integration Classification
AI Select Similar Components	Yes	Design validation
AI Selection Prediction	Yes	Designcenter NX Human Modeling
Designcenter NX Copilot	Yes	Designcenter NX Human Modeling Posture Prediction
Mechanical		Designcenter NX Motion
Industrial design and styling		Designcenter NX Animation Designer
Designcenter NX Render	Yes	Designcenter NX Check-Mate Runtime
Designcenter NX Realize Shape	Yes	Designcenter NX Check-Mate Author
Designcenter NX Draw Shape	Yes	Designcenter NX VDA 4955 Checker
Product design		Designcenter NX HD3D Visual Reporting
Designcenter NX WAVE Control	Yes	Designcenter NX One-Step Formability Analysis
Designcenter NX Assembly Path Planning	Yes	Designcenter NX Mold Cooling
Designcenter NX Structure Designer	—	Designcenter NX DFM Advisor
Designcenter NX Platform Design	Yes	Designcenter NX CFD Designer
Designcenter NX Topology Optimizer	Yes	Routed systems
Designcenter NX Design Space Explorer	Yes	Designcenter NX Diagramming
Designcenter NX Performance Predictor	Yes	Designcenter NX Routing Base
Designcenter NX Advanced Sheet Metal	Yes	Designcenter NX Routing Piping and Tubing
Designcenter NX Fabric Flatteners	Yes	Designcenter NX Routing HVAC
Designcenter NX Weld Assistant	Yes	Designcenter NX Penetration Management
Designcenter NX Physical Architecture Diagram Author	—	
Designcenter NX Physical Architecture Diagram Viewer	—	

Electrical

Electrical systems

Designcenter NX Routing Cabling	Yes
Designcenter NX Cable Router	Yes
Designcenter NX Routing Harness	Yes

PCB systems

Designcenter NX Flexible Printed Circuit Design	Yes
---	-----

Process

Jig, fixture and tooling

Designcenter NX Mold Wizard	Yes
Designcenter NX Molded Part Designer	Yes
Designcenter NX Electrode Design	Yes
Designcenter NX Progressive Die Wizard	Yes
Designcenter NX Die Structure Design	Yes
Designcenter NX Die Engineering	Yes
Designcenter NX Molded Part Validation	Yes
Designcenter NX Conformal Cooling Channel Design	Yes
Designcenter NX Tooling Locators	Yes

Industry-specific applications

Designcenter NX General Packaging	Yes
Designcenter NX Aerospace Design	Yes

Designcenter NX Ship Structure Basic Design	—
Designcenter NX Ship Structure Detail Design	—
Designcenter NX Ship Structure Manufacturing Preparation	—
Designcenter NX Ship Manufacturing Super Plate	—
Designcenter NX Ship Drafting	—
Designcenter NX Ship General Arrangement Design	—
Designcenter NX Rules Based Structure Welding	—
Designcenter NX for BIM	Yes
Designcenter NX for Concrete Design	Yes
Part manufacturing	
Designcenter NX Staged Models	Yes
Designcenter NX Process Planner	Yes
Designcenter NX Process Modeler	Yes
Designcenter NX Process Instructor	Yes
Automation	
Mechatronic design	
Designcenter NX Mechatronics Concept Designer	Yes
Designcenter NX MCD Player	Yes

Siemens Digital Industries Software
siemens.com/software

Americas
 1 800 498 5351

Europe
 00 800 70002222

Asia-Pacific
 001 800 03061910

For additional numbers, click [here](#).

© 2025 Siemens. A list of relevant Siemens trademarks can be found [here](#). Other trademarks belong to their respective owners.